



Yuasa Technical Data Sheet

Yuasa YB12A-A - YuMicron Battery

Performance

Voltage	12V
Capacity (10-hour)	12Ah
Capacity (20-hour)	12.6Ah
CCA @ -18°C	150A

Dimensions (±2mm)

Length	134mm
Width	80mm
Height	160mm

Weights & Measures

Mean Weight with Acid	4.1kg
Acid Volume	0.8l

Mounting Angle

Angle A	Vertical only
Angle B	Vertical only
Angle C	Vertical only

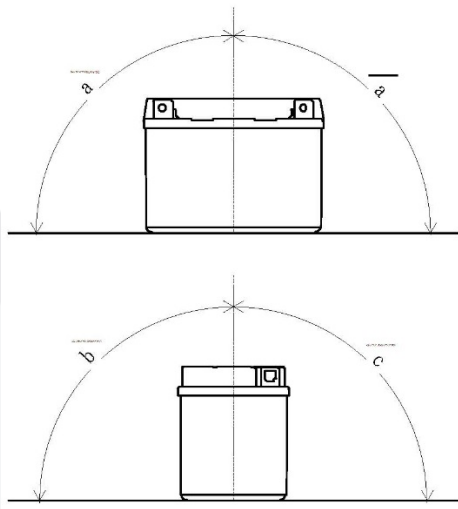

Cell Assembly Layout



Terminal Type - 6



Data Sheet generated on 12/12/2016 - E&OE