



## Yuasa Technical Data Sheet

### Yuasa YB30L-B - YuMicron Battery

#### Performance

Voltage	12V
Capacity (10-hour)	30Ah
Capacity (20-hour)	31.6Ah
CCA @ -18°C	300A

#### Dimensions (±2mm)

Length	168mm
Width	132mm
Height	176mm

#### Weights & Measures

Mean Weight with Acid	8.5kg
Acid Volume	1.7l

#### Mounting Angle

Angle A	Vertical only
Angle B	Vertical only
Angle C	Vertical only

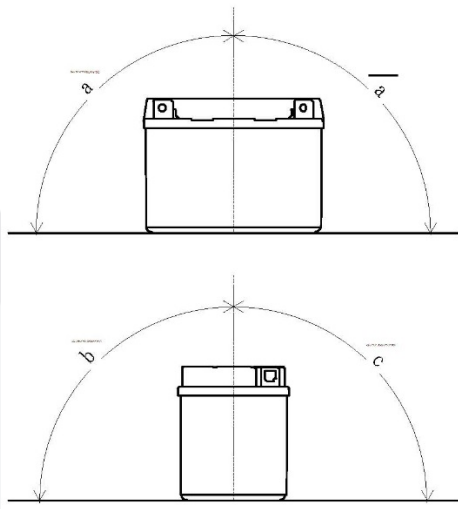

#### Cell Assembly Layout

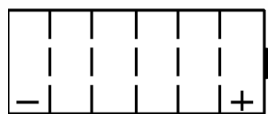

#### Terminal Type - 4



Data Sheet generated on 12/12/2016 - E&OE