



Yuasa Technical Data Sheet

Yuasa YTZ7S - High Performance Maintenance Free Battery

Performance

Voltage	12V
Capacity (10-hour)	6Ah
Capacity (20-hour)	6.3Ah
CCA @ -18°C	130A

Dimensions (±2mm)

Length	113mm
Width	70mm
Height	105mm

Weights & Measures

Mean Weight with Acid	2.1kg
-----------------------	-------

Mounting Angle

Angle A	40°
Angle B	90°
Angle C	15°

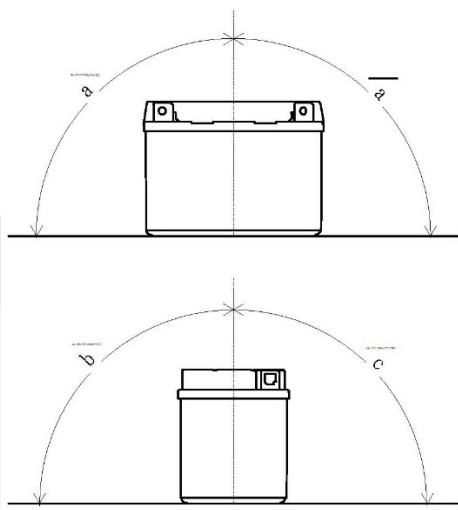

Technology

Technology
Separator

Exp Ca/Ca
AGM

Cell Assembly Layout



Terminal Type - 5



Data Sheet generated on 12/12/2016 - E&OE