



Yuasa Technical Data Sheet

Yuasa YTX20-BS - Maintenance Free Battery

Performance

Voltage	12V
Capacity (10-hour)	18Ah
Capacity (20-hour)	18.9Ah
CCA @ -18°C	270A

Dimensions (±2mm)

Length	175mm
Width	87mm
Height	155mm

Weights & Measures

Mean Weight with Acid	6.7kg
Acid Volume	0.93l

Mounting Angle

Angle A	30°
Angle B	20°
Angle C	20°

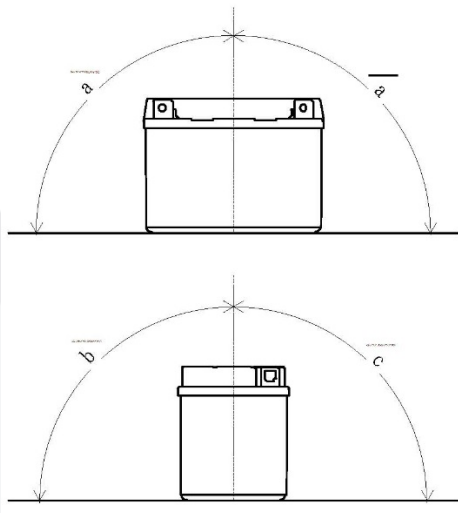

Technology

Separator AGM

Cell Assembly Layout

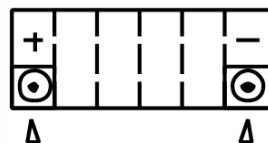

Terminal Type - 4



Data Sheet generated on 12/12/2016 - E&OE