

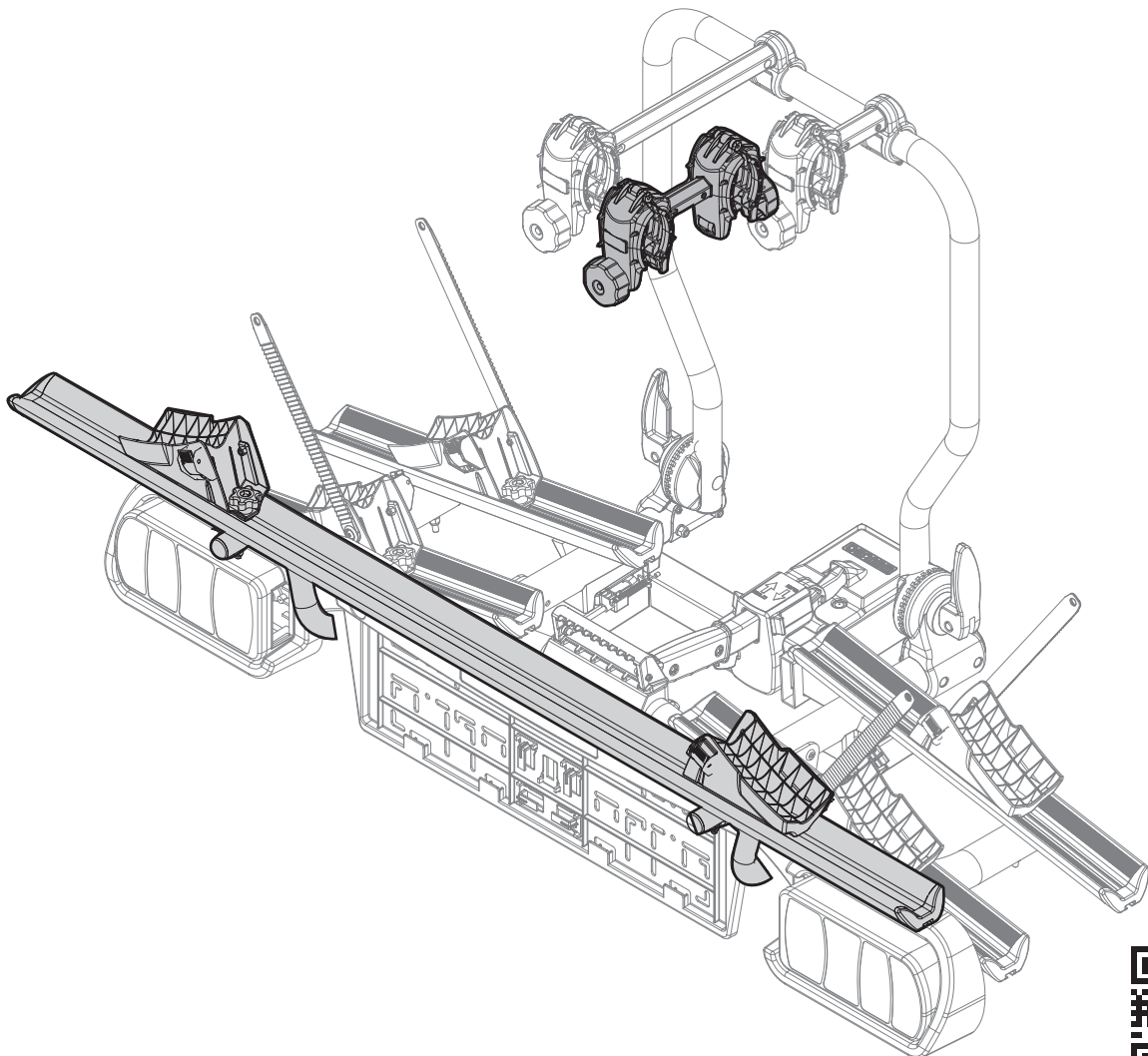



















MENABO

















your freetime on the move

ALPHARD KIT+1

IT	Istruzioni di montaggio	LV	Pritvirtinimo instrukcijas
EN	Fitting instructions	NL	Instrukcja montażu
DE	Montageanleitung	NO	Monteringsveiledning
FR	Instructions de montage	PL	Instrukcja montażu
ES	Instrucciones de montaje	PT	Instruções de Montagem
CZ	Návod na montáž	RO	Instrucțiuni de montare
DA	Monteringsvejledning	RU	Инструкции по установке
EL	Οδηγίες συναρμολόγησης	SK	Návod na montáž
ET	Paigaldusjuhend	SL	Navodila za pritrjevanje
FI	Asennusohje	SV	Monteringsanvisning
HR	Uputa za sastavljanje	TK	Uydurma talimat
HU	A felszerelés módja	ZH	裝修指導
LT	Stiprināšanas instrukcija	AR	تعليمات التجميع





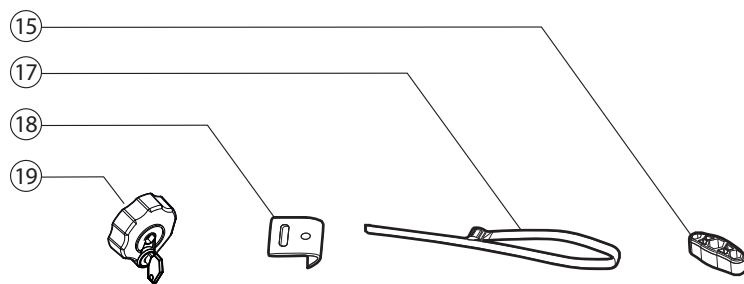
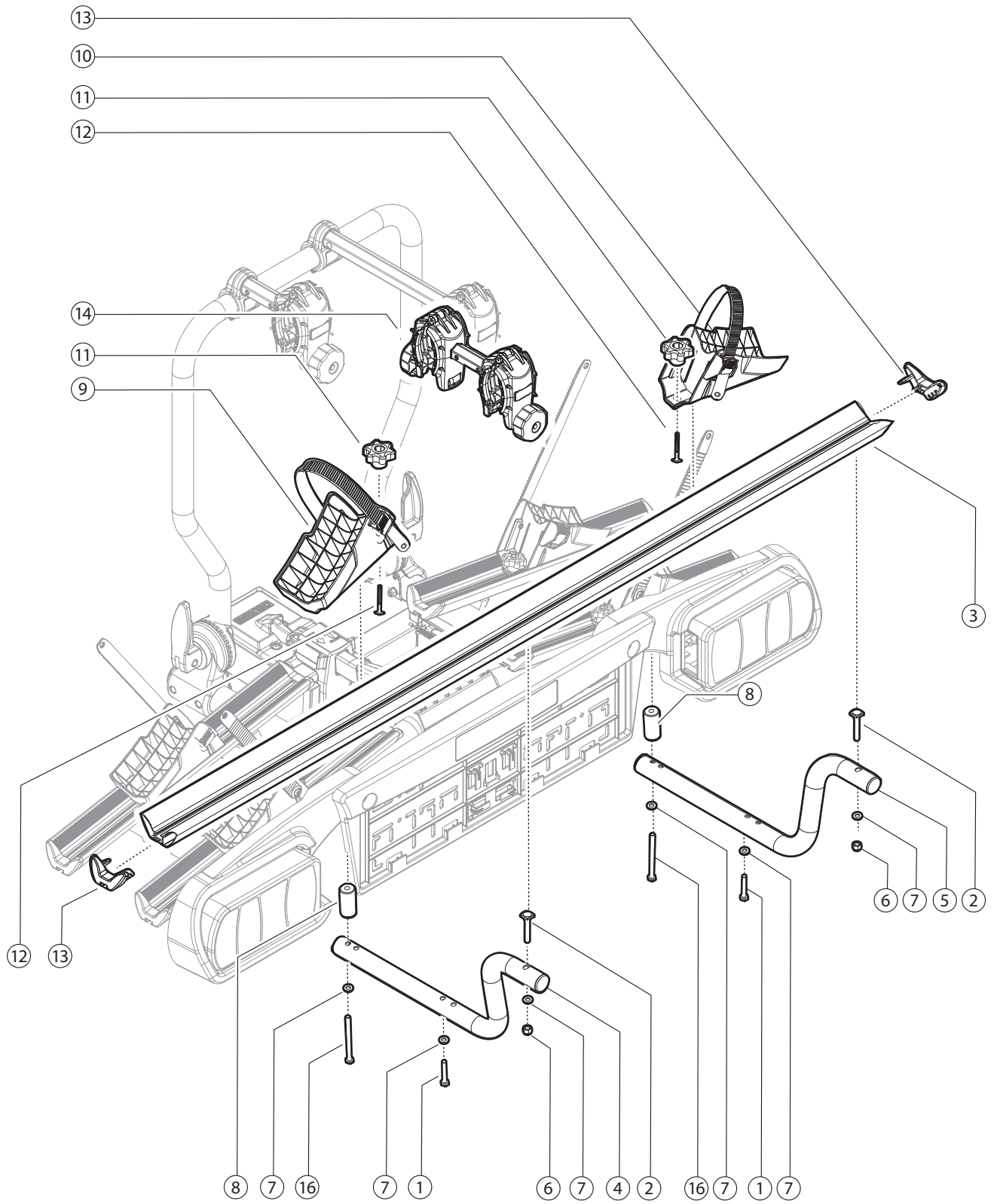

N	<ul style="list-style-type: none"> I Componenti (Inclusi) GB Components (Included) F Composants (Comprises) DE Die Komponenten (im Lieferumfang enthalten) E Componentes (Incluido) RU Компоненты (в комплекте) 		Q
1	 M6x35	2	
2	 M6x35	2	
3		1	
4	 sx	1	
5	 dx	1	
6	 M6	2	
7	 M6	6	
8		2	
9	 sx	1	
10	 dx	1	
11		2	
12	 6x25	2	
13		2	
14		1	
15		1	
16	 M6x70	2	
17	 2,5mt - 8,2 ft	1	
18		1	
19		2	

N	<ul style="list-style-type: none"> I Ricambi (A Richiesta) GB Spare Parts (Made to order) F Pièces de rechange (Sur commande) DE E Teile (auf Anfrage) E Piezas de recambio (Previa solicitud) RU Запасные части (по запросу) 		Q	Codice - Code Código - код
1	 M6x35	2	700023500000	
2	 M6x35	2		
6	 M6	2		
7	 M6	6		
12	 6x25	2		
16	 M6x70	2		
8		1	700023600000	
9	 sx	1	700017400000	
10	 dx	1		
11		1	700001300000	
12	 6x25	1		
13		2	700015500000	
14		1	700006900000	
15		1	700017500000	
17	 2,5mt - 8,2 ft	1	700001100000	
18		1	700004700000	
19		1	000026400000	





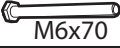

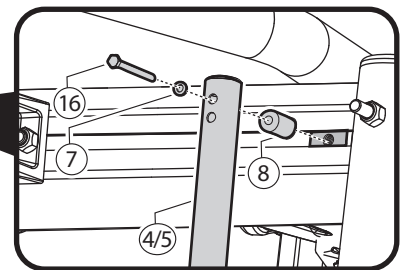
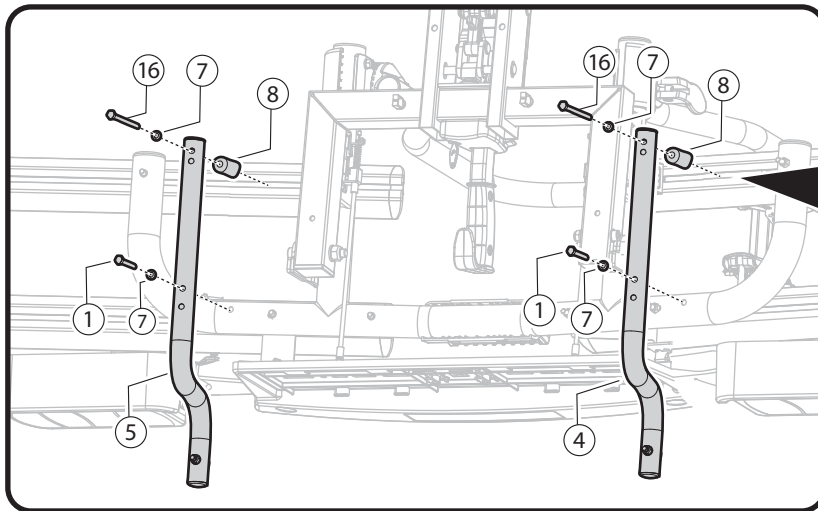
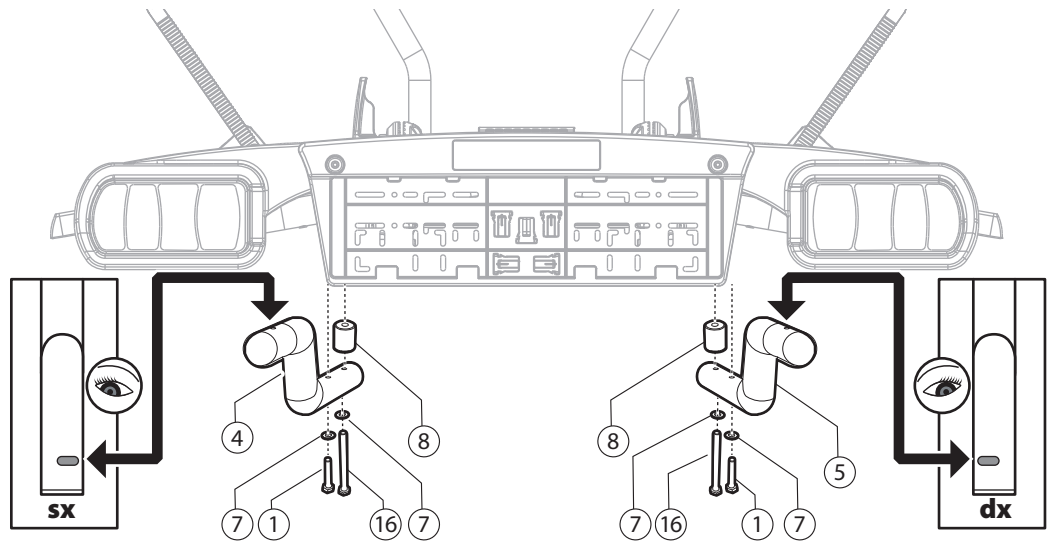
1

N		Q
1	 M6x35	2
4	 sx	1
5	 dx	1
7	 M6	4
8		2
16	 M6x70	2



2

N		Q
2	 M6x35	2
3		1
6	 M6	2
7	 M6	2

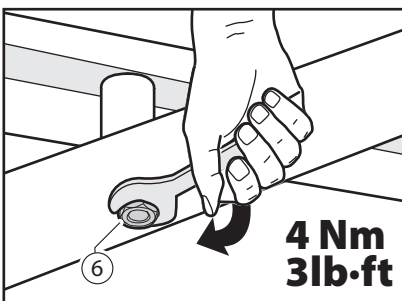
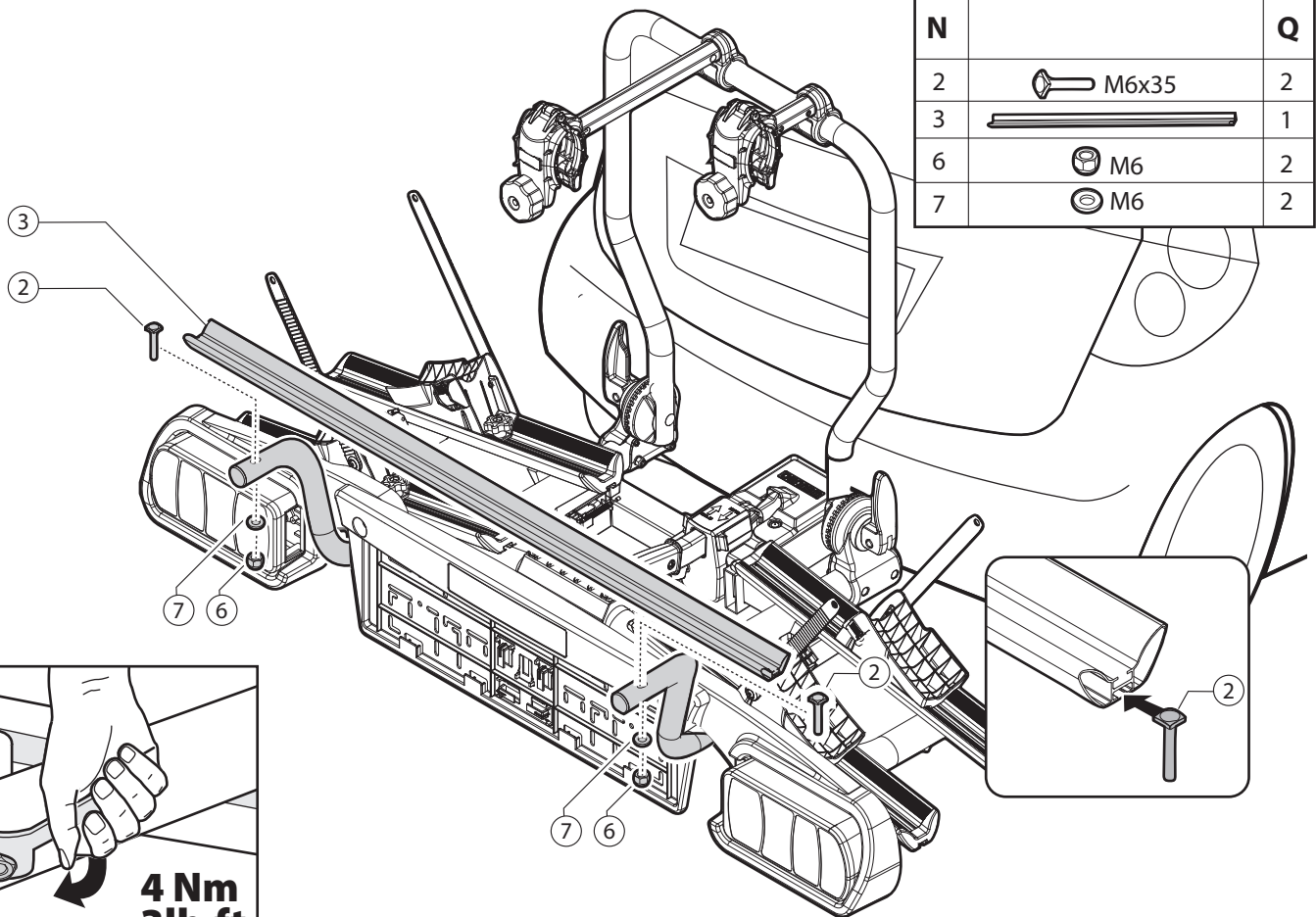

3

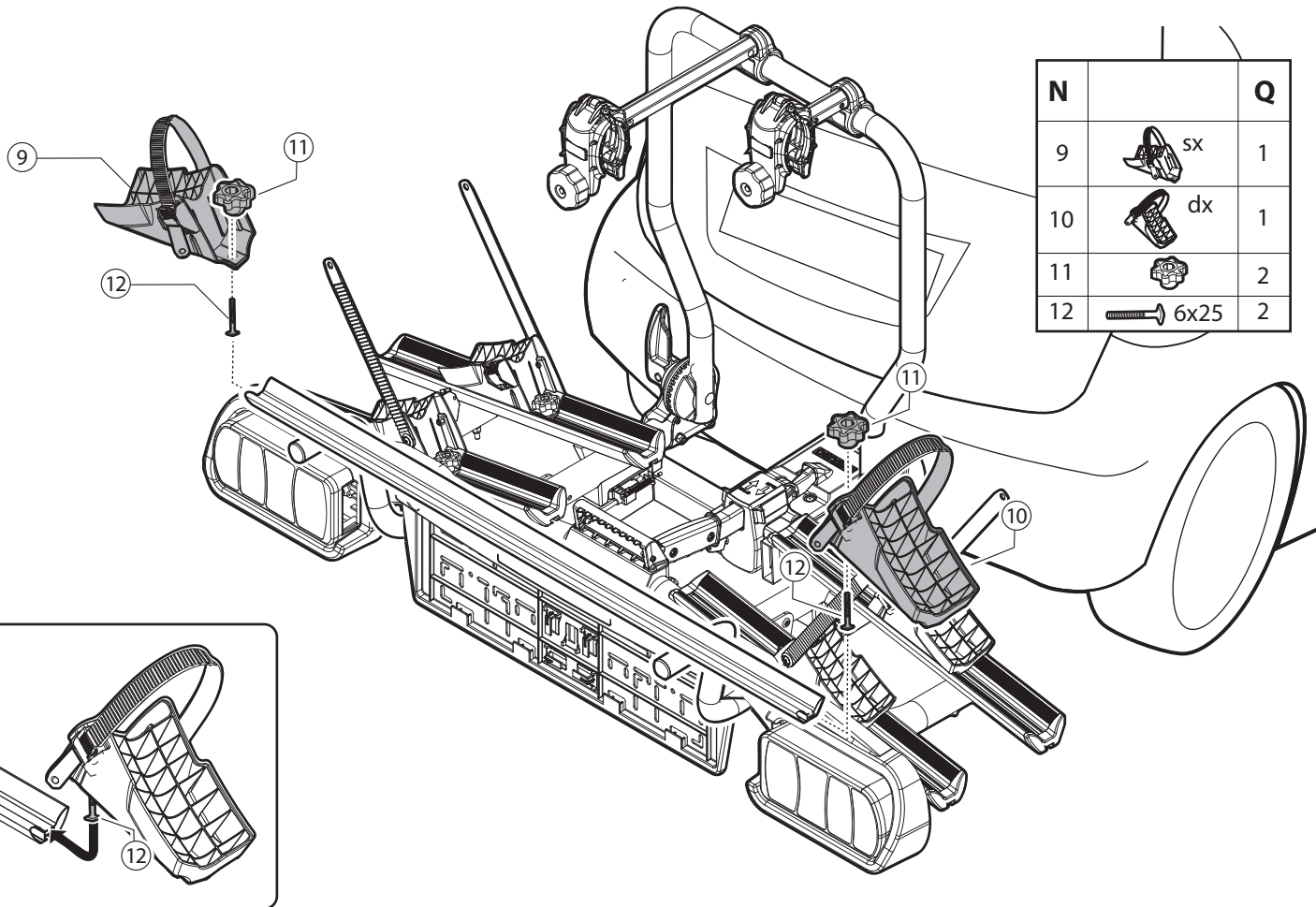

N		Q
9	SX	1
10	dx	1
11		2
12	6x25	2

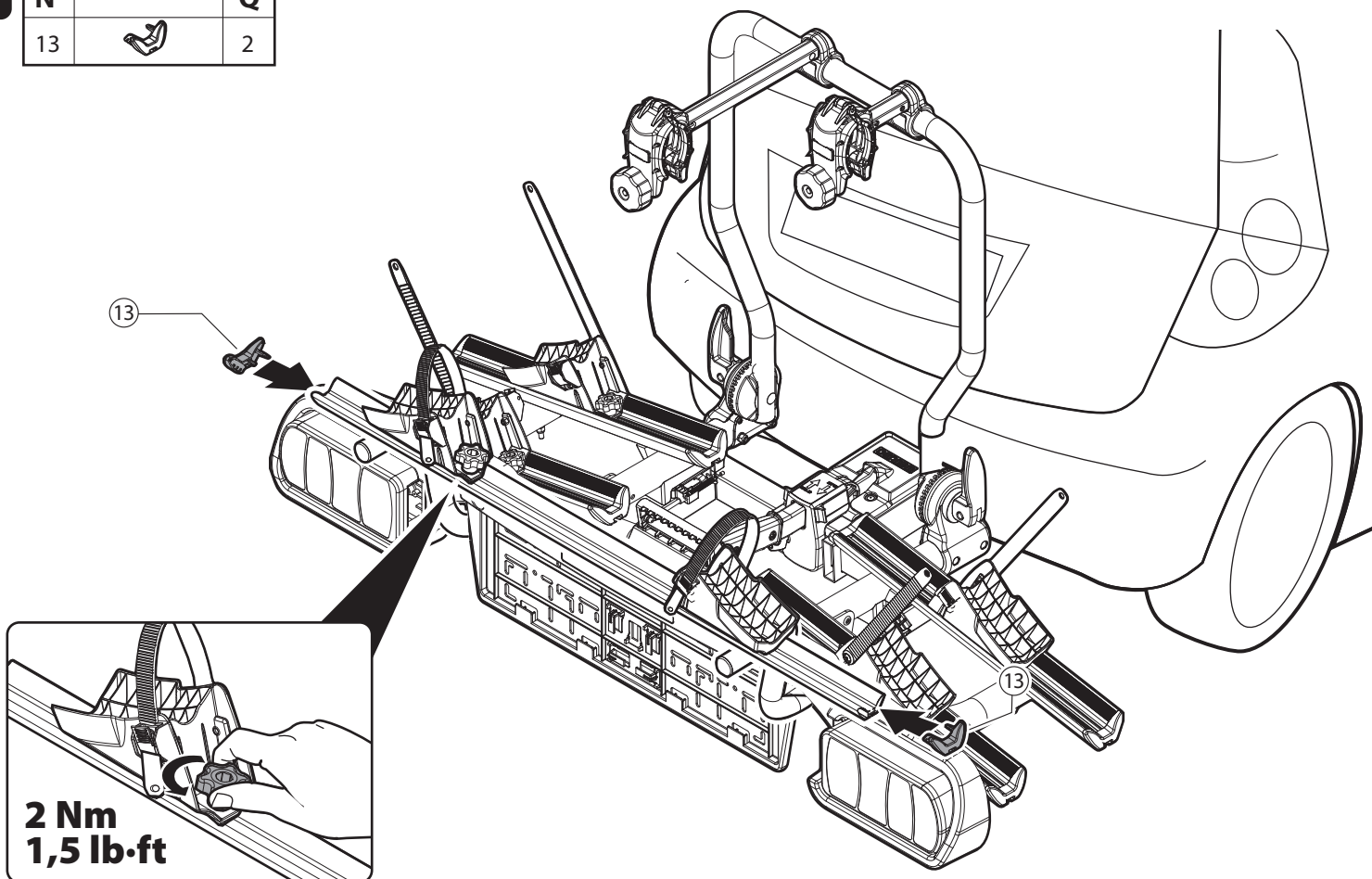

4

N		Q
13		2





2 Nm
1,5 lb·ft

5

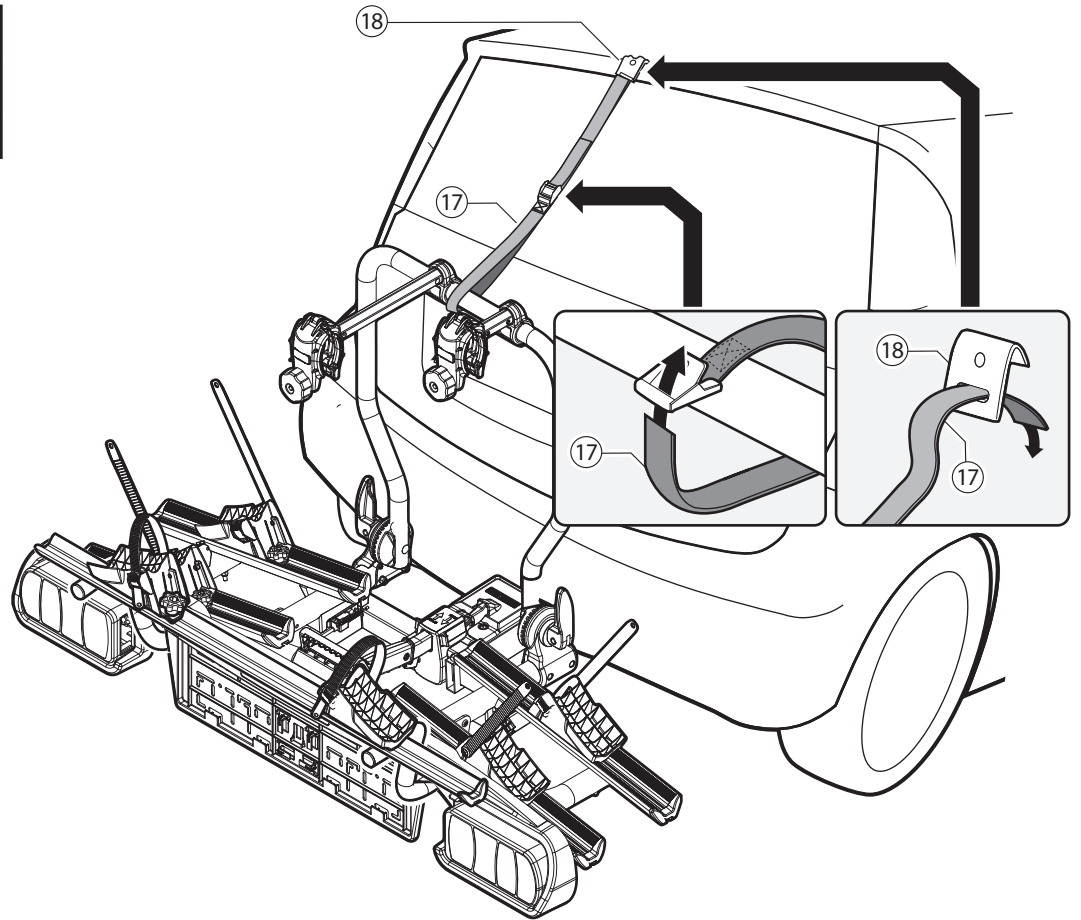
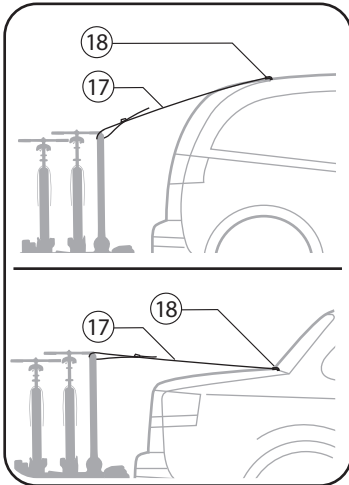
N		Q
17	 2,5mt - 8,2 ft	1
18		1

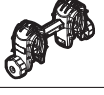
**6**

N		Q
14		1
19		2

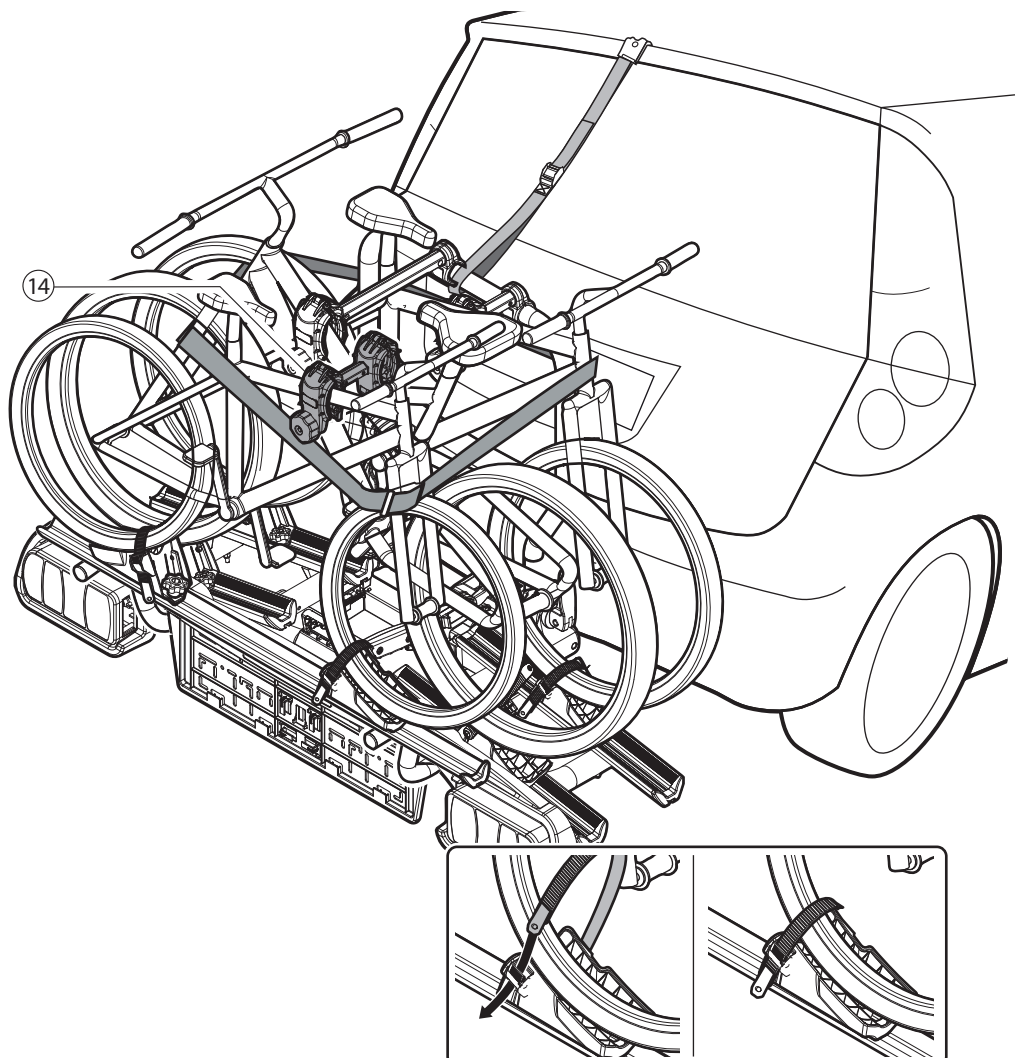
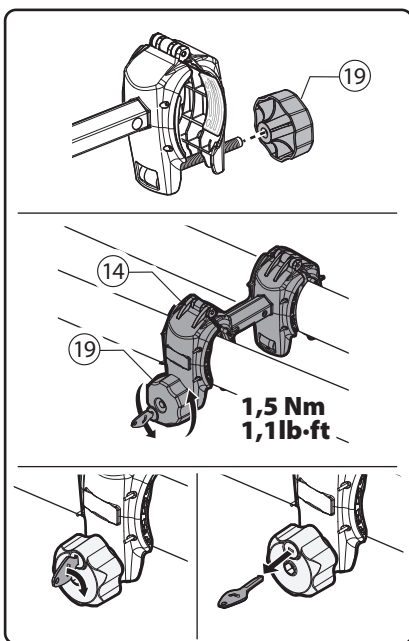

	<p>● MIN Ø30mm / 1,2" MAX Ø50mm / 2"</p> <p>● MIN 30x60mm / 1,2"x 2,3" MAX 50x70mm / 2"x 2,7"</p>		<p>MIN 22" MAX 29"</p>		<p>MAX 75mm / 3"</p>		<p>MAX 125cm / 59,8"</p>
---	---	---	--	---	-----------------------------	---	---------------------------------



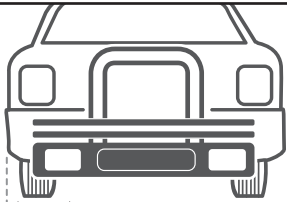



40 cm 15,7"

 **No Tandem**



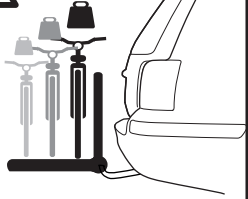
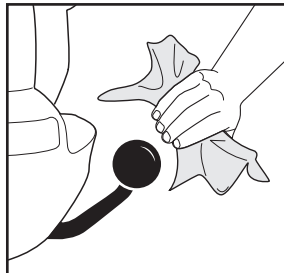





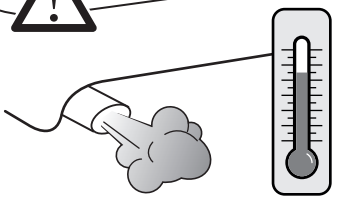











TILTING SYSTEM





130
km/h

80
mph



 **SPEED** 

 **SPEED** 

<p>MAX</p>  <p>94/20/CE STANDARD</p>			 x3	 KG
	16,2 kg - 35,7 lbs	2,7 kg - 6 lbs	MAX 15kg - 33 lbs	
	50 kg - 110,2 lbs	18,9 kg - 41,6 lbs	MAX 31,1 kg - 68,6 lbs	
	60 kg - 132,2 lbs		MAX 41,1 kg - 90,6 lbs	
	70 kg - 154,3 lbs		MAX 45 kg - 99,2 lbs	
>70 kg - 154,3 lbs	MAX 45 kg - 99,2 lbs			

Cod. Istr.	Data	Creato da	Approvato da
500005800000	09/01/2018	NP	EL

F.lli Menabò S.r.l.
Via 8 Marzo, 3
I - 42025 Cavriago (RE)
Tel. +39-0522/942840
Fax. +39-0522/942948
e-mail: info@flli-menabo.it
Web-site: www.flli-menabo.it